



**vimec** homelift

## STYLE AND DESIGN

OUR STORY BEGAN, AND CONTINUES, IN THE MOTOR VALLEY, IN THE HEART OF THE EMILIA-ROMAGNA REGION. THIS HEART ALSO BEATS TO GUARANTEE EXCELLENT QUALITY AND SERVICE. OUR PRODUCTS ARE TRULY MADE IN ITALY, WITH OVER 75% OF OUR SUPPLIERS WITHIN A FEW KILOMETRES FROM THE LUZZARA PRODUCTION SITE.

## EXPERIENCE

FROM 1980 TO TODAY WE ENGAGED WITH THOUSANDS OF CUSTOMERS AND PROFESSIONALS, AND TOGETHER WE DESIGNED AND PRODUCED A GREAT MANY CUSTOMIZED INSTALLATIONS. WORLDWIDE THERE ARE MORE THAN 20,000 VIMEC HOMELIFTS.

## INNOVATION AND TECHNOLOGY

WE ARE COMMITTED TO PROVIDING THE BEST CUSTOMER EXPERIENCE, AND TO DO THIS WE REDESIGNED ALL THE CONTROLS AND THE FLOW OF MATERIALS TOGETHER WITH OUR TECHNOLOGICAL PARTNERS.

## ENVIRONMENTAL SUSTAINABILITY

TRANSPARENCY AND PASSION GUIDE US IN EVERY EFFORT WE MAKE TO REDUCE OUR CARBON FOOTPRINT. WE TAKE CARE OF THE FUTURE, OURS AND OUR CUSTOMERS', AND WE ARE ALL PART OF THE PROJECT TO ENSURE OUR PLANET REMAINS THE MOST BEAUTIFUL PLACE TO LIVE.

## NUMBERS

THE LUZZARA FACTORY EXTENDS OVER MORE THAN 20,000 m<sup>2</sup>. WE HAVE 5 EUROPEAN COMMERCIAL BRANCHES. VIMEC EMPLOYS 170 PEOPLE, WITH MORE THAN 100 TECHNICAL PARTNERS IN ITALY AND OVER 400 WORLDWIDE.



## HOME LIFT SENSES AND SENSATIONS

### ENVIRONMENTAL SUSTAINABILITY

ONLY **CERTIFIED AND RECYCLABLE** MATERIALS, WITH REDUCED ENVIRONMENTAL IMPACT, INCLUDING **WOOD**. HOME LIFT PUTS INTO PRACTICE VIMEC'S PHILOSOPHY TOWARDS PLANET EARTH: REDUCING OUR CARBON FOOTPRINT IS PART OF THE INVESTMENTS MADE WITHIN THE COMPANY'S SOCIAL RESPONSIBILITY.



### TOUCH

TOUCH THE MATERIALS, THE WALLS AND THE FLOORS, TOUCH THE BUTTON PANEL: THE SENSE OF TOUCH AND THE TACTILE SENSATIONS ALSO WANT THEIR PART. THE **PRESTIGE** OF YOUR HOME LIFT IS ALSO ROOTED IN THE **EXCLUSIVE DETAILS AND FINISHES**, DESIGNED FOR YOUR HOME, AND THEREFORE DIFFERENT FROM THE USUAL MATERIALS USED IN LIFTS FOR MANY DIFFERENT AUDIENCES.



### BREATHE

THE **SAFETY** FEATURES FOR THE CORRECT **AIR** FLOW ARE IN THE CABIN SYSTEM: THE AIR INTAKES ABOVE THE CEILING ARE NOT VISIBLE, TO RESPECT THE ELEGANCE OF THE FORMS; YOU CAN **STAY** IN THE CABIN AS LONG AS YOU WANT, WITHOUT WORRIES.

### LIGHTING

THROUGH A SIMPLE APP, OR SUPPLEMENTING AN ALREADY INSTALLED HOME AUTOMATION SYSTEM, THE BLUETOOTH PROTOCOL OF YOUR HOME LIFT ALLOWS YOU TO ADJUST THE LIGHTING'S **INTENSITY**, THE LIGHT'S **WARMTH** AND THE COLOUR **TONES**, AVAILABLE IN **72 MILLION SHADES**. A POWERFUL TOOL TO CUSTOMIZE YOUR CABIN RIGHT AT YOUR FINGERTIPS.



### IoT

IT MEANS **INTERNET OF THINGS**. YOUR HOME LIFT ALREADY CONTAINS A BOARD TO ACCOMMODATE THE IMPLEMENTATIONS AVAILABLE IN THE VERY NEAR FUTURE: KNOW THE STATUS OF YOUR PRECIOUS HOME LIFT, AND EXCHANGE DATA REGARDING USE AND SAFETY, TOGETHER WITH SUGGESTIONS FOR ITS BEST USE AND FOR MAINTAINING ITS **TOP EFFICIENCY OVER TIME**.





## 72 MILLION CUSTOMIZATIONS

AN EXCLUSIVE THAT IS TAILOR-MADE FOR YOUR HOME LIFT, TO HIGHLIGHT YOUR MOODS, CHANGING THE COLOURS DURING AN EVENING WITH FRIENDS, OR SIMPLY TO RELAX WHILE IN THE KITCHEN WITH YOUR FAMILY OR IN THE LIVING ROOM, IN FRONT OF THE TV. YOU CAN CREATE A SPECIAL ATMOSPHERE, WHICH CAN MAKE YOU APPRECIATE YOUR HOME EVEN MORE.



## TABLE OF CONTENTS

VIMEC HOME LIFT HAS BEEN DESIGNED TO **ADD VALUE TO YOUR HOME**: THE STARTING POINT ARE THE MINIMAL STYLE LINES, WHICH ARE ENRICHED WITH FINISHES AND LIGHTS FOR A **TRULY TAILORED RESULT**.

EACH **INSPIRATION** REPRESENTS A STYLE OF FURNITURE: YOU CAN MIX YOUR **PERSONALIZATION CHOICES** TO FIND THE PERFECT SELECTION FOR YOU AND YOUR HOME.



CONTEMPORARY

PAG.

# 16

ELEGANT, CONTEMPORARY, GLAMOUR, MINIMAL, LINEAR, PRESTIGIOUS, SUSTAINABLE.



NEW CLASSIC

PAG.

# 20

CLASSIC, ELEGANT, CHIC, BONTON, REASSURING, ROMANTIC, PRESTIGIOUS.



NORDIC

PAG.

# 24

CREATIVE, NATURAL, BRIGHT, LIFESTYLE, ECO-FRIENDLY, YOUNG, SOBRE.



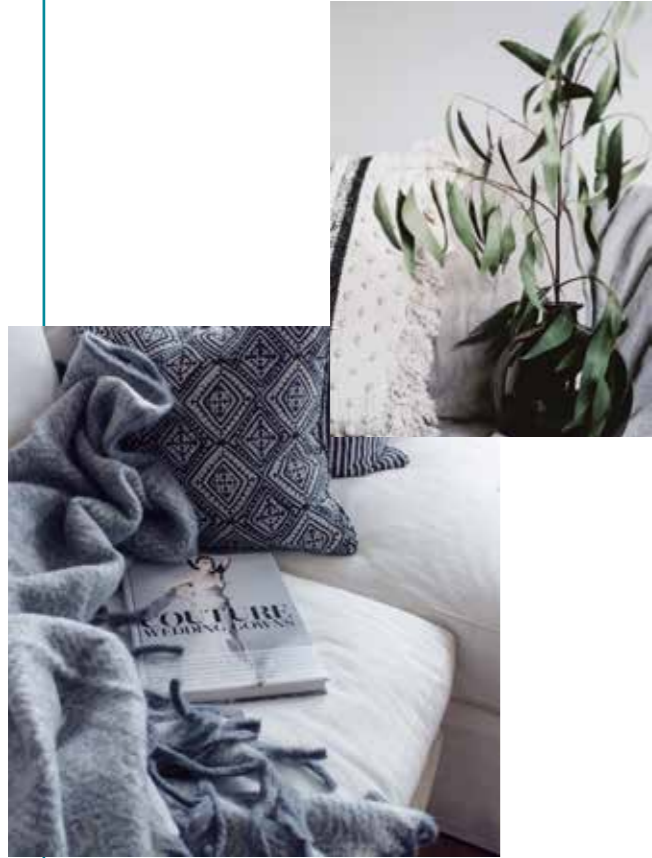

**NATURAL** PAG. **30**

ECO-FRIENDLY, CULTURED,  
INFORMED, SELECTIVE, COMMITTED,  
ECO-FRIENDLY, SUSTAINABLE.



**URBAN** PAG. **36**

RECOVERED, METROPOLITAN,  
MIX&MATCH, ECO-FRIENDLY, BRIGHT,  
TRENDSETTER.



**CONTEMPORARY  
OUTDOOR** PAG. **40**

ECO-FRIENDLY, ELEGANT, SOPHISTICATED,  
VERSATILE, INNOVATIVE, PRESTIGIOUS,  
CULTURED.



**COUNTRY CHIC** PAG. **44**

ROMANTIC, GENUINE, WARM,  
TRADITIONAL, FAMILIAR,  
WELCOMING, DAILY.







**MATERIAL,  
TECHNOLOGY  
AND DESIGN**

THE NATURAL QUALITY AND AUTHENTICITY  
OF WOOD, THE INNOVATION AND THE  
TACTILE COMFORT OF TOUCH TECHNOLOGY:  
A PERFECT MATCH, RIGHT IN YOUR HOME.





**PRECIOUS DETAILS  
AND SENSATIONS**

WITH "MADE IN ITALY" ELEGANCE AND INNOVATION,  
A HOMELIFT VIMEC IS LIKE AN EXTRA ROOM  
THAT CAN GIVE PRESTIGE AND COMPLETENESS  
TO YOUR HOME.





## DECORATING WITH LIGHT

GREEN SOUL AND YOUNG CHARACTER. LIVING INDOOR AND OUTDOOR HOME SPACES IN HARMONY.









**ECO-SUSTAINABLE  
NATURAL QUALITY**

WITH THE BEAUTY OF CONSCIOUSLY CHOSEN SUSTAINABLE MATERIALS, VIMEC HOMELIFT ADAPTS TO THE STYLE OF YOUR ENVIRONMENTS WITH CUSTOMIZABLE COLOURS.







# SHADES AND HOME AUTOMATION

ENVIRONMENTS THAT TELL THE STORIES, THE EXPERIENCES, THE LIVES OF PEOPLE: THE HOMELIFT EXPRESSES YOUR EMOTIONS THROUGH AN ATMOSPHERE OF COLOURS.

ADJUSTABLE NUANCES, THE SECRET OF THE VIMEC HOME.





**RELAXATION  
WITH A VIEW**

THE AESTHETIC OF THE HOMELIFT LENDS ITSELF TO UNPRECEDENTED INDOOR AND OUTDOOR ARCHITECTURES. THE SOPHISTICATED FINISHES GIVE ELEGANCE AND AUTHENTICITY TO DOMESTIC ENVIRONMENTS.





**TRADITIONAL FLAVOUR  
AND THE WARMTH  
OF YOUR HOME**

SHARE MOMENTS IN A SPACE ACCESSIBLE  
TO ALL, WITH SIMPLICITY AND EASE OF USE  
OVER TIME.





## FEATURES AND TECHNICAL DATA



### ELECTRIC HOME LIFT

THE ECO-FRIENDLY CHOICE IS AN OIL-FREE SYSTEM, WITH A UNIQUE PROJECT ON THE MARKET, THANKS TO MRL TECHNOLOGY (MACHINE ROOMLESS, NO EXTRA SPACE REQUIRED BEYOND THE SHAFT).



### SAFETY DEVICES AND BATTERIES

FULL-HEIGHT PHOTOCCELL BARRIERS, BACK-UP BATTERIES TO RETURN TO THE LANDING AND OPEN THE DOORS IN CASE OF ELECTRIC POWER FAILURE: THE TECHNICAL FEATURES ARE THE BEST OF **THE STATE OF THE ART**.



### UPGRADE

VIMEC HOMELIFT IS DESIGNED TO LAST OVER TIME! THAT IS WHY ALL THE CABIN DETAILS ARE DESIGNED TO ALLOW UPGRADES IN THE FINISHES, REPLACEMENTS OF PARTS, OR THE IMPLEMENTATION OF MATERIALS WITHOUT HAVING TO DISASSEMBLE THE ENTIRE SYSTEM: A GREAT BENEFIT FOR THE WHOLE FAMILY, WITH THE OPTION OF ADDING VALUE AND CUSTOMIZATION EASILY AND SAFELY.



### COMFORT AND SILENCE

THE INVERTER PROVIDES A GENTLE AND CONTROLLED DEPARTURE AND ARRIVAL, TRAVELLING IN COMFORT, HOME LIFT IS TRULY QUIET: ALL THE CONSTRUCTION DETAILS, SUCH AS THE LOW PLACEMENT OF THE MOTOR, THE QUALITY OF THE CABIN STRUCTURE AND THE DOOR MECHANISM ARE DESIGNED TO REDUCE VIBRATIONS AND KEEP NOISE TO A MINIMUM, FOR QUALITY THAT LASTS OVER TIME.



### FAST INSTALLATION AND MAINTENANCE

FROM THE PACKAGING TO THE PRE-WIRING, EVERY STEP IS DEDICATED TO FOCUSING ON THE QUALITY OF THE INSTALLATION. IN THE CASE OF TWO STOPS IN A MASONRY SHAFT, IT CAN BE INSTALLED IN LESS THAN THREE DAYS. THE SYSTEM'S SIMPLICITY OF MAINTENANCE, WHICH IS CARRIED OUT DIRECTLY FROM INSIDE THE CABIN, TOGETHER WITH THE SAFETY DEVICES FOR THE TECHNICAL OPERATORS INSTALLED BOTH IN THE PIT OF THE SYSTEM AND IN THE HEADROOM, ARE A REFERENCE FOR THE ENTIRE SECTOR AND REDUCE THE MAINTENANCE COSTS: THE SIMPLICITY AND SECURITY ARE TRANSPARENT!

### HOME LIFT E20 - GENERAL FEATURES

TRACTION ENGINE	1,5 kW - 220 v 50 hz
BELT DRIVE, FOR A SMOOTH AND SOFT MOVEMENT	
AUXILIARY SUPPLY VOLTAGE	24 v
LOAD CAPACITY	UP TO 400 kg
HEAVY LOAD VERSION LOAD CAPACITY	UP TO 500 kg
SPEED	UP TO 0,15 m/s
VERSION HS (EXTRA EU) SPEED	UP TO 0,26 m/s
TRAVEL	MAX 14,6 m
ACCESS N *6 MAX, ON FLOOR N * 2 MAX	

ARRIVAL AT THE FLOOR AND SOFT STOP WITH THE "SOFT START/STOP" SYSTEM	
ELECTRICAL SAFETY LOCKS	
FLOOR CALL CONTROLS WITH "SIMPLE TOUCH"	
MINIMUM HEADROOM	2.450 mm
MINIMUM HEADROOM WITH ON DOOR CABIN	2.600 mm
PIT MASONRY	120 mm
STEEL STRUCTURE	140 mm
STANDARD CABIN HEIGHT	2.100 mm
DOORS HEIGHT	2.000 mm

### HOME LIFT E20 - INSIDE THE CABIN

INFRARED LIGHT BARRIERS ON THE ENTRANCE SIDES
DIALER TO COMMUNICATE WITH THE OUTSIDE
EMERGENCY BUTTON PROVIDED WITH SWING DOORS
OVER LOAD INDICATOR
CONTROL BUTTONS HEIGHT ACCORDING TO EN 81-41
MIRROR (OPTIONAL): ALWAYS FLUSH VERSION
HANDLE (OPTIONAL): AVAILABLE IN ROUND OR SQUARED VERSION

DATA ARE INDICATIVE AND NOT BINDING. VIMEC RESERVES THE RIGHT TO INSERT ANY MODIFICATION WITHOUT NOTICE.

## HOME LIFT'S INSPIRATIONS:

A MINIMAL ENVIRONMENT, WHICH ENHANCES THE PERSONALIZATION OF THE WALL WITH THE BUTTON PANEL, ALWAYS MADE IN WOOD. THE STAINLESS STEEL FRAME AND THE ACCESSORIES ENHANCE THE CHOICE OF MATERIALS, AND THE WHITE WALLS ALLOW THE LIGHTING EFFECTS TO STAND OUT.

WITH THE HOME LIFT E20, YOU CAN MATCH THE PLATFORM AND THE WALLS OF THE CABIN. IT BECOMES EASY TO BE INSPIRED AND CHOOSE THE MOOD THAT MOST REPRESENTS YOUR HOME STYLE.

### WALL WITH CABIN BUTTON PANEL

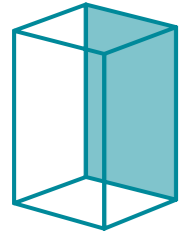

#### CONTEMPORARY\*



ROBUR WOOD

#### NEW CLASSIC\*



FABRIC

#### NORDIC



WHITE SQUARED

#### NATURAL



CLOUD

#### COUNTRY CHIC



WHITE WOOD

#### URBAN\*

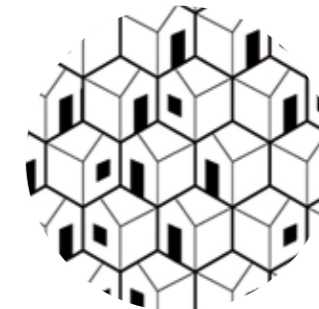

LITTLE HOMES

N.B. THE MOODS/INSPIRATIONS ARE AVAILABLE FOR THE WALL WITH THE BUTTON PANEL

### CABIN PLATFORM

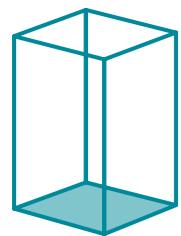

SMOOTH ANTHRACITE



GREY WOOD



BLONDE WOOD

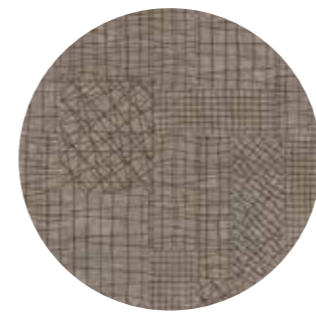

SMOOTH PALM



ARDESIA



NOCE WOOD

### ALTERNATIVES FOR WALLS WITH BUTTON PANEL\*

#### CONTEMPORARY

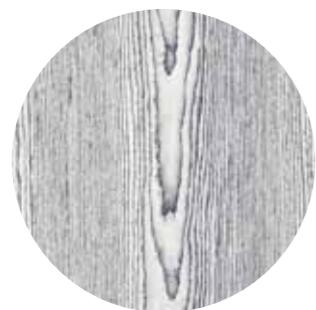

FENICE

#### NEW CLASSIC



FACTORY GREY

#### URBAN

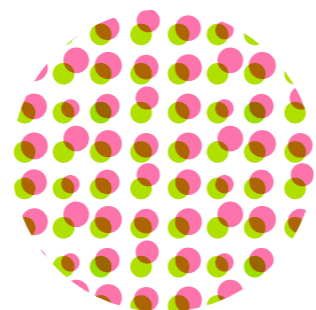

LITTLE ROUNDS

### ALTERNATIVE PLATFORMS\*



BLACK CHARCOAL



GREY FLOTEX SMOOTH

### CABIN STANDARD VERSION

ALL WALLS IN WHITE FINISHING

WALL WITH BUTTON PANEL IN WHITE WOOD (THE MOODS/INSPIRATIONS UPGRADE IS AVAILABLE)

BLACK MECHANICAL BUTTON PANEL WITH DISPLAY AND BRUSHED STAINLESS STEEL FRAME

BLACK CHARCOAL FLOOR

72 MILLION CUSTOMIZABLE LIGHTS

THE WALL ACROSS FROM THE BUTTON PANEL CAN HOLD THE FIVE LED STRIPS, THE MIRROR, GLASS AND HANDLE

A WALL ON THE SIDE OF THE BUTTON PANEL HOLDS THE FIVE LED STRIPS OR IT CAN HOLD THE MIRROR, GLASS AND HANDLE

**FINISHES:  
COLOURS OF LOAD-BEARING  
STRUCTURES AND CABIN DOORS**

**COLOURS OF  
LOAD-BEARING  
STRUCTURES**

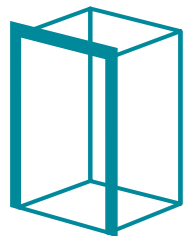

**WHITE**

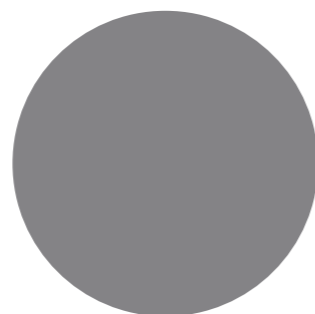

**7040 GREY  
STANDARD**

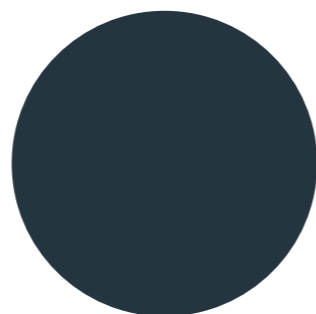

**7016 ANTHRACITE  
GREY**



**1013 IVORY**

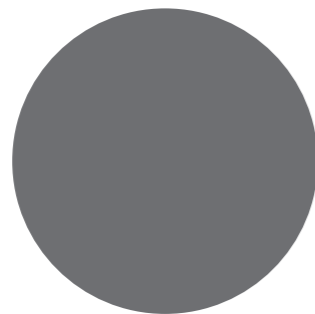

**9023 PEARL  
DARK GREY**



**SPECIAL RAL**

**COLOURS  
CABIN DOORS**

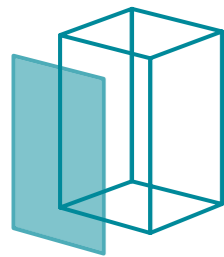

**WHITE**

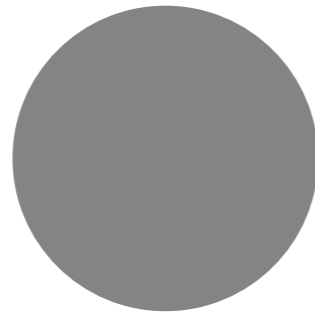

**7040 GREY  
STANDARD**



**INOX**



**SPECIAL RAL**

**CLOSING METHOD**

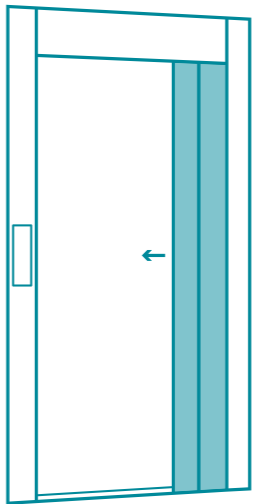

**TELESCOPIC  
2-LEAF DOOR**

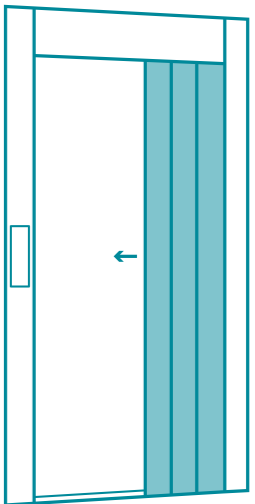

**TELESCOPIC  
3-LEAF DOOR**

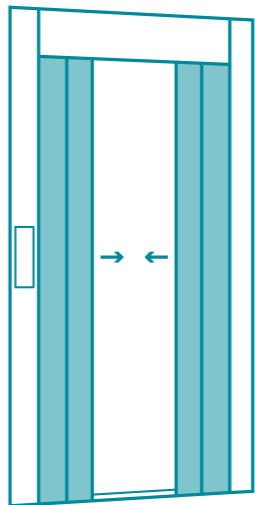

**TELESCOPIC  
4-LEAF DOOR**

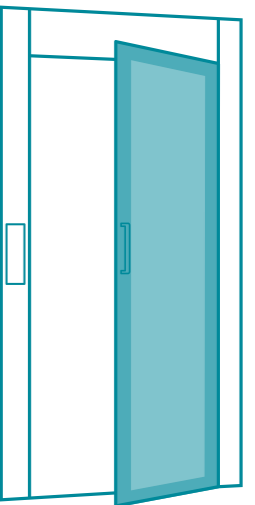

**ALUMINIUM  
PANORAMIC DOOR**

# FINISHES: BUTTON PANEL

## EXTERNAL BUTTON PANEL AT FLOOR



TOUCH SCREEN  
WHIT DISPLAY



TOUCH SCREEN  
WHIT DISPLAY



TOUCH  
SCREEN



TOUCH  
SCREEN



MADE OF STAINLESS  
STEEL WITH BUTTON



MADE OF STAINLESS  
STEEL WITH STANDARD  
BUTTON

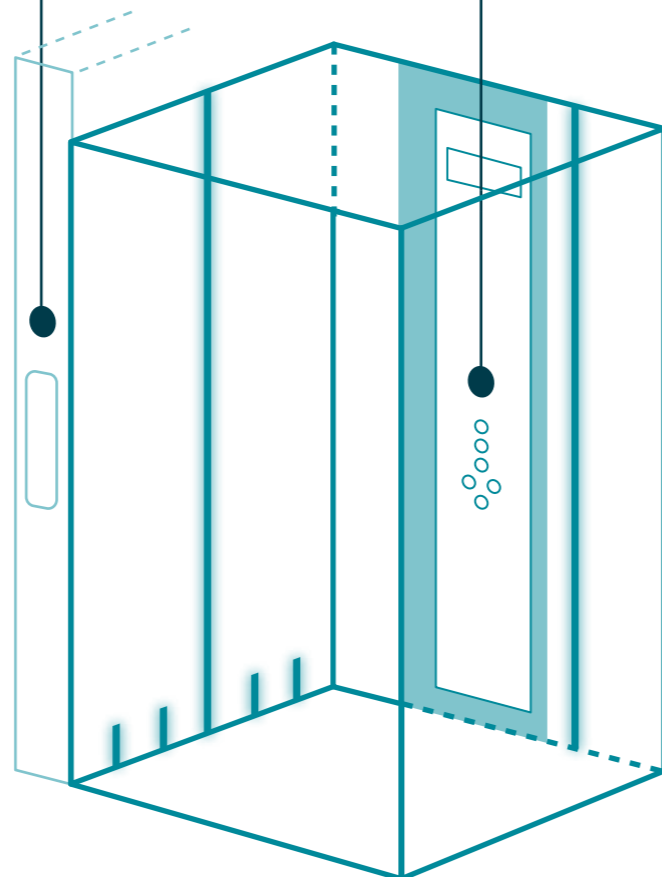

## ON-BOARD BUTTON PANEL

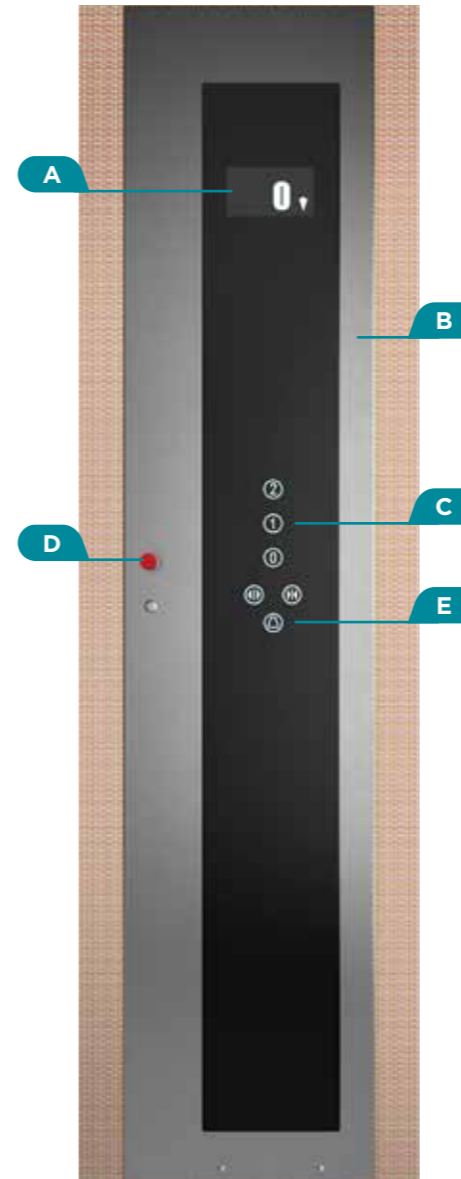

BLACK GLASS  
TOUCH SCREEN



WHITE GLASS  
TOUCH SCREEN



BLACK  
WITH BUTTONS



WHITE  
WITH BUTTONS

### TECHNICAL DATA ABOUT TOUCH BUTTON PANEL

- A. DISPLAY TFT
- B. BRUSHED STAINLESS STEEL FRAME, TO GO WITH THE FLOWING LINES OF THE CABIN DESIGN
- C. TOUCH BUTTONS ON HI-TECH MIRRORED BLACK GLASS H
- D. RED STOP BUTTON
- E. TELEPHONE DIAL PAD

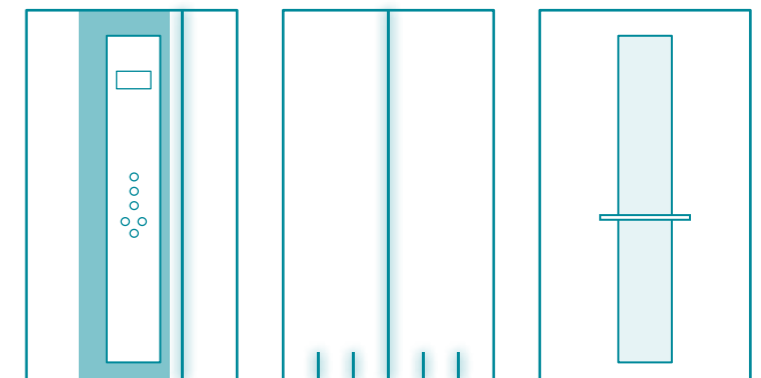

## FINISHES: HANDLE AND METAL STRUCTURES

### MANIGLIONI



SQUARE HANDLE  
(OPTIONAL)

HANDLE WITH  
ROUNDED CORNERS  
(OPTIONAL)

### METAL STRUCTURES FOR EXTERIORS

THE HOME LIFT SOLUTION IS AVAILABLE BOTH FOR MASONRY SHAFTS OR WITH METAL STRUCTURES SUPPLIED DIRECTLY BY VIMEC. VIMEC HOME LIFTS CAN BE INSTALLED BOTH INSIDE A HOME AND OUTDOORS.

#### PLATFORM SIZES (IN mm, FLOOR SURFACE)

##### STANDARD

900X800	900X900	1000X900	1000X1000	900X1400
1100X1400	1250X800	1250X1000	1400X900	1400X1140

THE SIZES AND THE FINISHES OF WALLS AND CABIN PLATFORMS CAN BE FULLY CUSTOMIZED.



## DIMENSIONS AND OVERALL SPACES

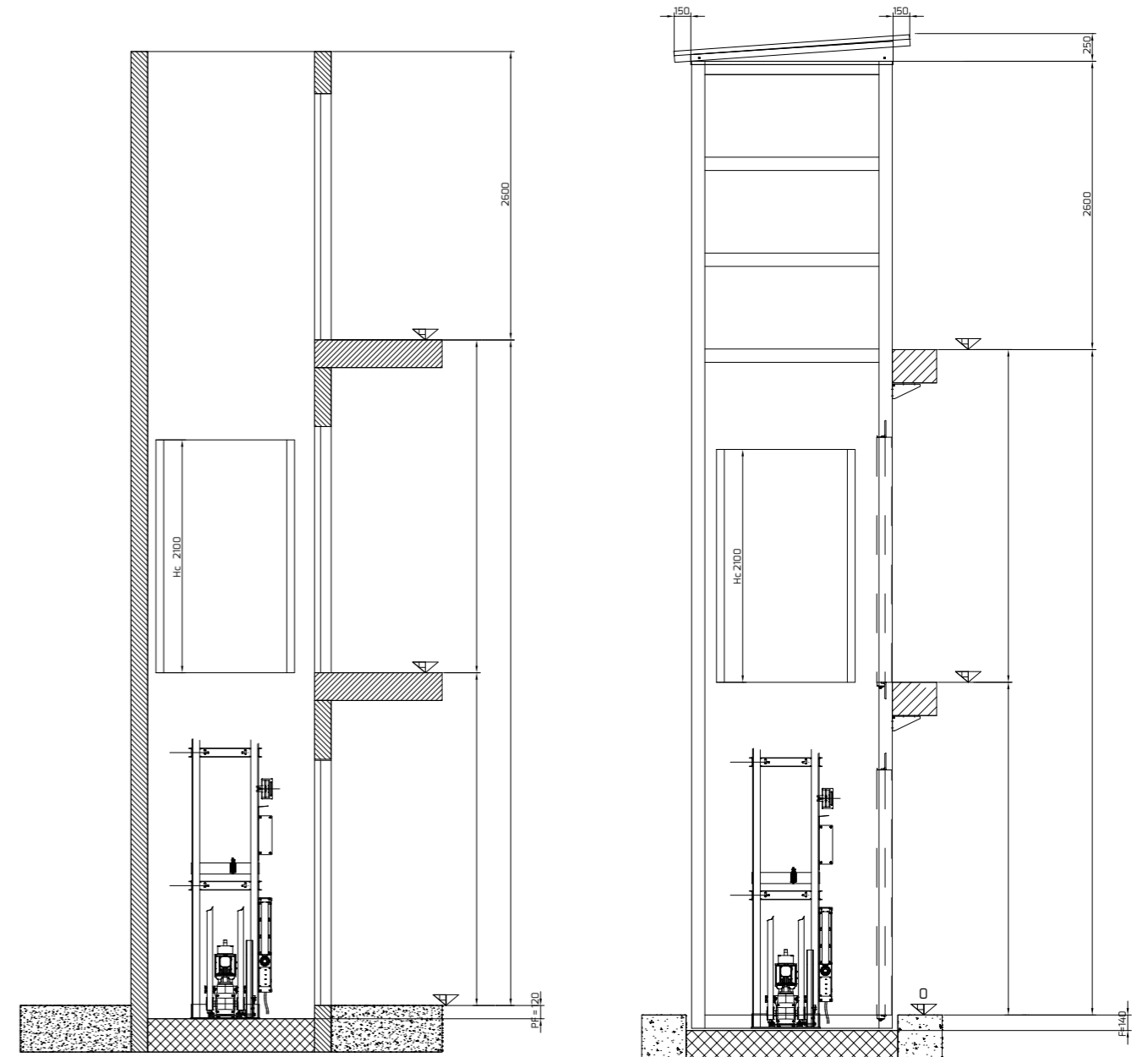

### MASONRY SHAFT

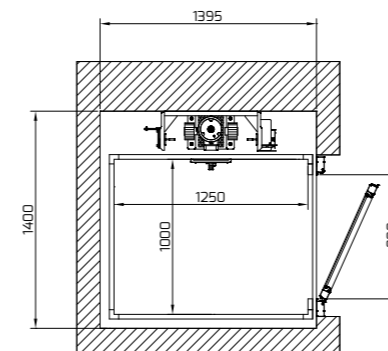

### STRUCTURE

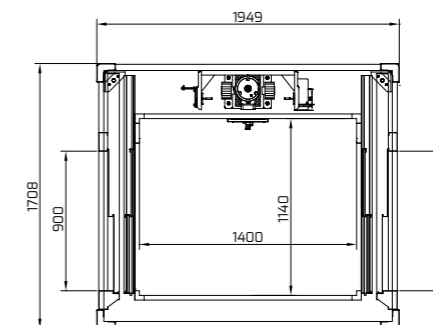

### WITH TELESCOPIC DOORS

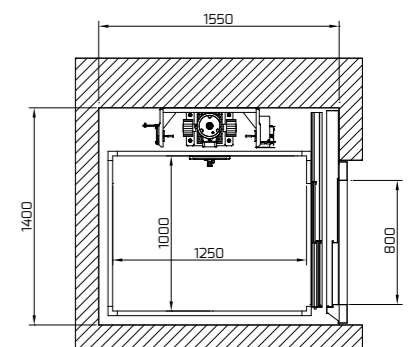

## GUARANTEED PRODUCT

A Vimec system is guaranteed up to 24 months from the date of installation and the warranty can be extended, thanks to the technical support centres located throughout the national provinces.

ART: KALIMERA.IT

**vimec** 40<sup>anni</sup>  
ver  
sary

Vimec was established in 1980 near to the Po river, between the provinces of Mantua and Reggio Emilia.

Over the years we have become leaders thanks to the values that guide us every day: people are our customers, whom we engage with passion, commitment and integrity, in order to provide the best consumer experience.

Vimec Homelift is the brand line for home elevators intended for people who are looking for elegance and comfort for their home, with particular attention to Italian design, technology and eco-sustainability.



AZIENDA CON SISTEMA QUALITÀ  
CERTIFICATO DA DNV  
= UNI EN ISO 9001/2008 =

*Made in Italy*



7510077-01092019 440/0

Numero Verde  
**800-204042**

**vimec** homelift

**VIMEC ACCESSIBILITY L.T.D.**

Suite 56 Basepoint Business Centre  
Caxton Close | Andover Hampshire SP10 3FG  
Fax +44 01606 330 777  
[export@vimec.biz](mailto:export@vimec.biz) | [www.vimec.biz/en](http://www.vimec.biz/en)

**HEADQUARTER:**

Luzzara (RE) | Italy  
[www.vimec.biz](http://www.vimec.biz)

**VIMEC SUBSIDIARIES:**

**Madrid** (Spain)  
**Avignon** (France)  
**St. Petersburg** (Russia)  
**London** (United Kingdom)  
**Warsaw** (Poland)

Company subject to management and coordination by Investmentaktiebolaget Latour.